

User's Manual

(English)

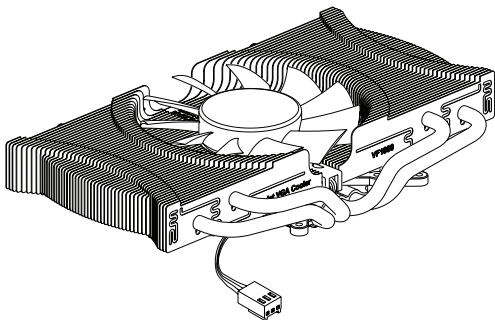

Ultra Quiet Heatpipe VGA Cooler

Model : VF1000 LED

Please visit our website (www.zalmanusa.com) and watch the VF1000 LED installation video for easy installation.

- ※ Please read this manual thoroughly before installation.
- ※ The specifications of this product and its components may change without prior notice to improve performance.

<http://www.zalman.co.kr> <http://www.zalmanusa.com>

Cautions on Use and Installation

1. By installing this product on a VGA (Video Graphics Array) card, a PCI slot adjacent to the PCIe (or AGP) slot will become unusable.
2. If this product is to be installed on a recently released VGA card, please check for compatibility at Zalman's website first.
3. The product cannot be installed on Matrox VGA cards, NVIDIA PCX 5***, NVIDIA Geforce 6600 AGP Series, Geforce 7600/7900 AGP Series, and ATI Radeon 9550/9600 Series.
4. If the VGA card and/or its components interfere with the installation of this product, then stop the installation, refer to the list of compatible VGA cards at Zalman's website, and install this product with one of the compatible VGA cards.
5. NVIDIA's Geforce 8800 Series requires the installation of Zalman's RAM Heatsink ZM-RHS88 before installing VF1000 LED.
6. The use of an exhaust fan positioned on the rear side of the case is recommended for enhancement of product performance.

Disclaimer

Zalman Tech Co., Ltd. is not responsible for any damages due to external causes, including but not limited to, improper use, problems with electrical power, accident, neglect, alteration, repair, improper installation, or improper testing.

Product Features

1. The product is equipped with Zalman's patented VFP (Variable Fin Profile) technology. Fan installed inside the heatsink maximizes the cooling efficiency and the product's maximized dissipation surface area provides excellent performance.
2. Use of four high performance heatpipes maximizes heat transfer.
3. Pure copper thin fins (0.3mm) for excellent cooling performance.
4. Cools not only the VGA chipset and VGA RAM, but all other VGA components as well.
5. 80mm Slim LED Fan for excellent performance and great aesthetics.
6. Newly improved installation structure provides easy installation and broad compatibility.
7. Adjustable fan speed controller (FAN MATE 2) enables control of noise and fan speed.
8. Does not generate noise or vibration in Silent Mode.

Specifications

1. Heatsink

- Dimensions (mm) : 160(L) X 80(W) X 30(H)
- Weight (g) : 380
- Materials
 - Dissipation Fins : Pure Copper
 - Base : Pure Copper
 - Heatpipe : Pure Copper

2. Fan

- Dimensions (mm) : 80(L) x 80(W) x 15(H)
- Bearing Type : 2-Ball Bearing
- Speed (using FAN MATE 2)
 - 1,400rpm \pm 10%(Silent Mode)
 - 2,500rpm \pm 10%(Normal Mode)
- Noise Level (using FAN MATE 2)
 - 18dBA \pm 10%(Silent Mode)
 - 28dBA \pm 10%(Normal Mode)

Components

- 1 One (1) VGA Cooler
- 2 Eight (8) RAM Heatsinks
- 3 Four (4) Nipples
- 4 Four (4) Fixing Nuts
- 5 Four (4) Fixing Nuts for SLI/CrossFire
- 6 One (1) PVC Washer Plate
- 7 Four (4) Rubber Rings
- 8 Four (4) Springs
- 9 One (1) Thermal Grease
- 10 One (1) Fan Controller (FAN MATE 2)
- 11 One (1) Cable for FAN MATE 2
- 12 One (1) Double-Sided Tape (to attach FAN MATE 2)
- 13 One (1) User's Manual

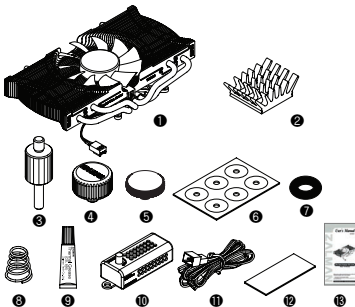

Exploded View

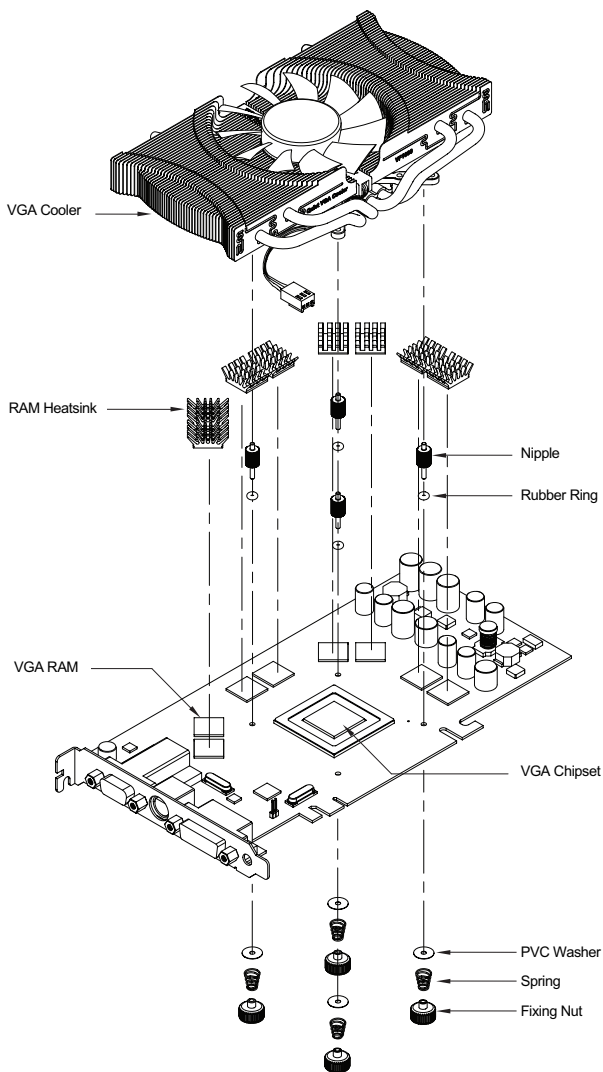

Installation Procedure

※ The following installation sequence **MUST** be followed.

- (1. VGA RAM Heatsink Attachment → 2. Thermal Grease Application → 3. Nipple Installation on Retention Guide → 4. VGA Cooler Installation → 5. Spring Insertion on the Fixing Nut → 6. Fixing Nut Assembly on VGA Cooler's Nipple → 7. VGA Card Installation → 8. Fan Power Cable Connection)

1. VGA RAM Heatsink Attachment

Remove the film from the Thermal Tapes on the bottom of the RAM Heatsinks and attach the Heatsinks on the VGA RAM.

Note 1) If Thermal Grease or other residue remains on the RAM, then the Thermal Tapes will not stick. Clean the surface of the RAM with acetone or alcohol before attaching the RAM Heatsinks.

Note 2) The bonding strength of the Thermal Tapes reaches 90% after 24 hours of curing. Do not exert excessive force on the RAM Heatsinks during this period.

Note 3) Thermal Tapes are not reusable because they lose adhesiveness after their initial application. Purchase new Thermal Tapes if the RAM Heatsinks need to be reattached.

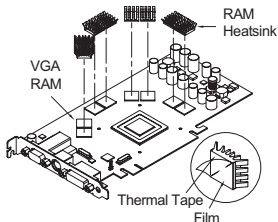

2. Thermal Grease Application

Clean the contact surface of the VGA Chipset completely. Apply Thermal Grease on the VGA Chipset that makes contact with the base of the VGA Cooler.

3. Nipple Installation on the Retention Guide

Install the short end of the Nipples on the VGA Cooler's Retention Guide after determining the appropriate Installation Holes.

(Note) The Nipples **MUST** be tightened by hand. Using tools to tighten the Nipples may damage the tips of the Nipples.

※ Please check the table below to identify the correct Nipple Installation Holes for specific models of VGA cards.

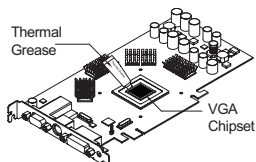

Nipple Installation Holes for Various VGA Cards

Nipple Installation Holes	VGA Card
①	ATI X1600 Series
	ATI X1300 Series
	ATI Radeon 9*** Series (except 9550/9600)
	ATI Radeon X*** Series
	NVIDIA GeForce4 MX Series
	NVIDIA GeForce FX 5200
	NVIDIA GeForce FX 5500
②	NVIDIA GeForce FX 5600 (FX 5700)
	NVIDIA GeForce 6600 Series (except 6600 AGP Series)
	NVIDIA GeForce4 TI 4 Series
	NVIDIA GeForce FX 5700(Ultra) Series
	NVIDIA GeForce FX 5800 Series
③	NVIDIA GeForce 6600 Series (except 6600 AGP Series)
	ATI HD 2600 Series
	ATI HD 2400 Series
	ATI X1650 Series
	ATI X1600 Series
	NVIDIA GeForce 8600 Series
	NVIDIA GeForce 8500 Series
	NVIDIA GeForce 7600 Series
	NVIDIA GeForce 7300 Series
	NVIDIA GeForce 6600 Series (except 6600 AGP Series)
④	NVIDIA GeForce FX 5900 Series
	NVIDIA GeForce FX 5950 Series
⑤	NVIDIA GeForce 8800GT, 8800GTS (G92)
	ATI HD 3870, HD 3850
	ATI X1950 Series, ATI X1900 Series
	ATI X1800 Series
	NVIDIA GeForce 7950 Series
⑥	NVIDIA GeForce 7900 Series
	NVIDIA GeForce 7600 Series
	NVIDIA GeForce 7800 Series
	NVIDIA GeForce 6800 Series
	NVIDIA GeForce 8800 Series (G80)

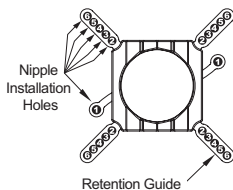
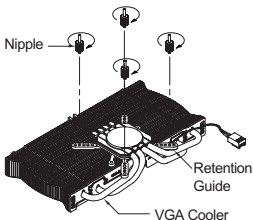

4. VGA Cooler Installation

- 1) Insert the Rubber Rings into the VGA Cooler's Nipples.
- 2) Install the Nipple-attached VGA Cooler on the VGA card's Mounting Holes.
- ※ The VGA Chipset MUST be positioned on the center of the VGA Cooler's base.
- 3) Simultaneously hold the VGA Cooler and the VGA card with one hand, then flip the VGA card so that its rear-side is facing upwards.

(Note)

Make sure that the VGA Chipset and the VGA Cooler's base do not get detached while simultaneously flipping the VGA Cooler and the VGA card.

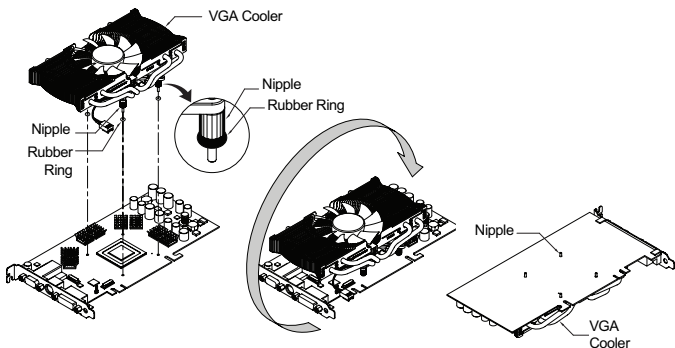

5. Spring Insertion on the Fixing Nut

Slowly turn the Spring in counter clockwise motion so that the Spring is correctly attached to the Fixing Nut.

Note 1) The ends of the Springs are of different diameters. Install the Spring end with the smaller diameter on the Fixing Nut as shown in the diagram.

Note 2) Make sure that the Spring is installed perpendicularly and not leaning to one side.

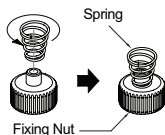

6. Fixing Nut Installation on the Nipples

- 1) Place a PVC Washer over each Nipple on the back side of the VGA card.
- 2) Slightly screw each of the four Spring-attached Fixing Nuts onto each Nipple, then tighten each Fixing Nut one rotation at a time until all are completely tightened.
- 3) Interference may occur between the Fixing Nuts of the two VGA coolers when using an SLI or CrossFire VGA card setup. In such a case, use the enclosed Fixing Nut for SLI /CrossFire for assembly.

Note 1) Fully tightening one Fixing Nut at a time may result in damaging the VGA chipset. Please tighten each Fixing Nut one rotation at a time until all are completely tightened.

Note 2) Make sure that the VGA Cooler's base and the VGA Chipset are completely in contact with each other.

Note 3) Make sure that the VGA Cooler does not interfere with the VGA card's capacitors and other components.

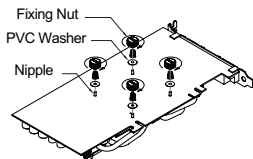

For SLI or CrossFire Installations

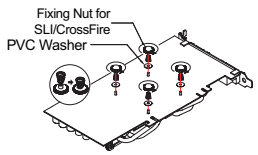

7. VGA Card Installation

Insert the assembled VGA card into the motherboard's PCIe (or AGP) slot. Use the Fixing Bolt to secure the VGA card onto the computer case. If the VGA card has a power connector on it, then remember to plug in the power cable.

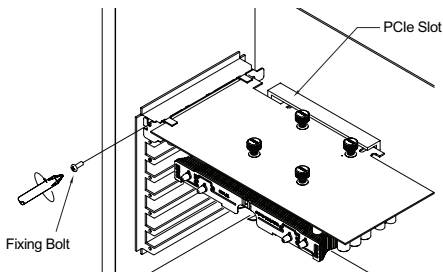

8. Fan Power Cable Connection

① Installing FAN MATE 2 on the Inside of the System

② Installing FAN MATE 2 on the Outside of the System

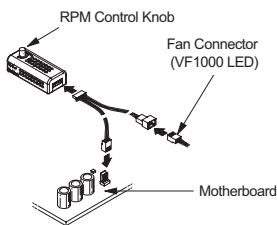

Connect the appropriate 3-pin connector on the cable to the motherboard fan header and the VF1000 LED fan connector.

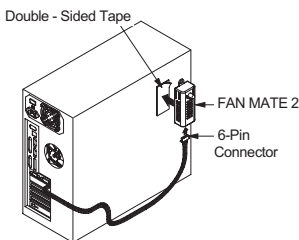

Pull the 6-pin connector out of the system through the back and connect it to FAN MATE 2, which should be installed on the case using the included Double-Sided tape (②).

- ◆ When the RPM Control Knob on FAN MATE 2 is turned fully counter-clockwise, the fan operates in Silent Mode. Turned fully clockwise, it operates in Normal Mode. You can select the desired fan RPM by turning the knob.

- ※ Performance can be increased by adjusting the RPM control knob of the FAN MATE 2.

Note) FAN MATE 2 has been specifically designed for the fan of this product.

Zalman Tech Co., Ltd. is not responsible for any damage to systems or VGA Chipsets caused by using it with other types of fans.

Zalman Computer Noise Prevention Systems

When building a noiseless computer, use Zalman's Ultra Quiet CPU Cooler, Noiseless Power Supply, Heatpipe HDD Cooler, Fanless Northbridge Cooler and Noiseless Case Fan for more stable performance and a noiseless environment.



Ultra Quiet CPU Cooler



Noiseless Power Supply



Heatpipe HDD Cooler

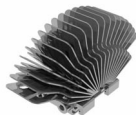

Fanless Northbridge Cooler



Noiseless Case FAN

Computer Enclosures



GT-1000

- High End Gaming Enclosure Built with Sturdy All Aluminum Panels
- Three Tool Free Hinged Magnetic Panels (2 Left, 1 Right) for Easy Installation and Access to Components
- Tool Free Installation of Disk Drives (HDD, ODD, FDD), Fan Controllers, Audio Interfaces etc.
- Accommodates up to 6 Hard Drives (4 in the HDD Chassis, 2 on the Bottom Panel)
- Luxurious and Cool Aesthetics
- Color Options : Black (Red LED Fans), Titanium (Blue LED Fans)

Home Theatre PC Enclosures



HD160XT

The HD160XT is designed for ultra quiet home theatre PC operation, utilizing optimized ventilation and anti-vibration reinforcements, making it ideal for environments that require silence such as living rooms, bedrooms, educational facilities, and offices.

For more information, please visit our website.



Disposal of Old Electrical & Electronic Equipment
(Applicable in the European Union and other European countries with separate collection systems)